

180 degrees peeling table P180-200N

Best for peeling test at 180 degrees.

1. Suitable for 180 degrees peeling test
2. For peeling measurement according to standard (JIS)

P180-200N







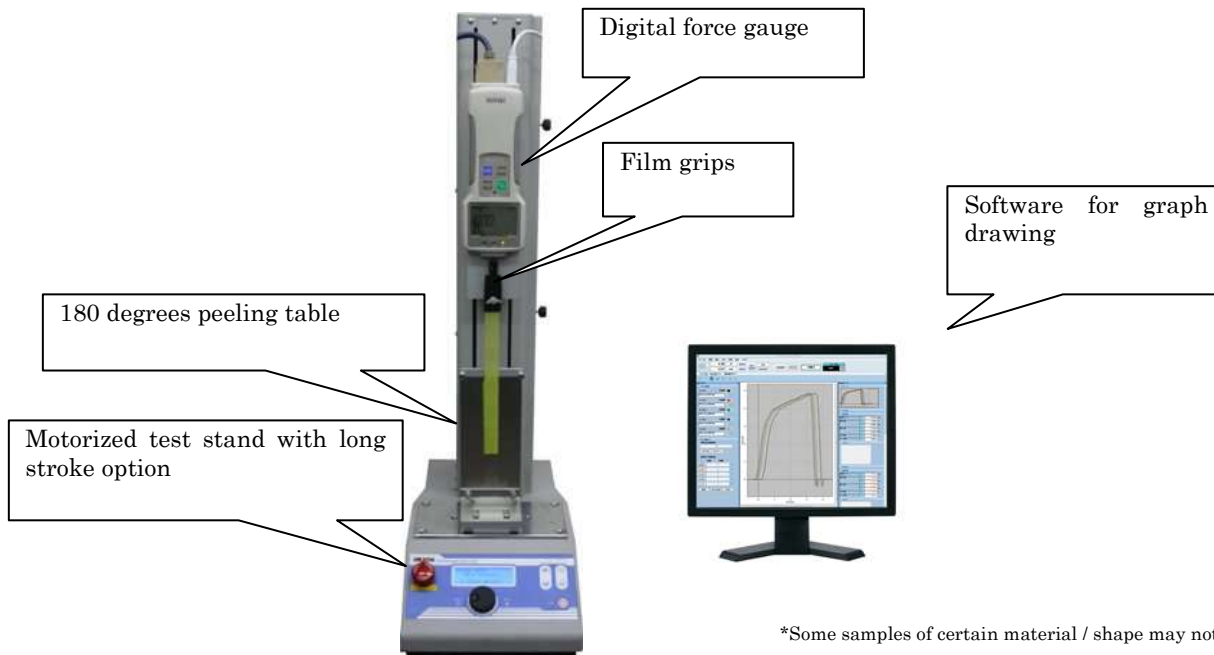

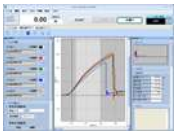

Feature 1	Feature 2	Feature 3
Simple test of 180 degree Peeling	Adjustable peeling angle	Meets JIS
Suitable for various materials of 180 degree peeling test because of its simple and easy operation.	Set table position (in front and back) to adjust peeling angle easily.	It meets Japanese Industrial Standards, JIS Z0237:2000 partly.

Composition example



*Some samples of certain material / shape may not be used with this

	180 degrees peeling table	Digital force gauge	Software for graph drawing	Cable for force control	Motorized test stand	Film grips
Case 1 [Standard measurement] To analyze the whole measurement by drawing graphs.		[ZT series] *1 	[Force Recorder Standard] 	[CB-518] *2 	[MX2-500N-L] *3 	[FC series] 
Case 2 [Economy measurement] To analyze the whole measurement by drawing graphs.		[DS2 series] *1 	[N/A]	[N/A]		

*1 It is appropriate to use Digital Force Gauge is recommended for adhesion test.

*2 We suggest using cables to avoid over load. (Available only with ZT series)

*3 Motorized Test Stand is suitable for adhesion test. We especially recommend using MX2 series with which test speed can be set.

Test example

Peeling test of plastic tape

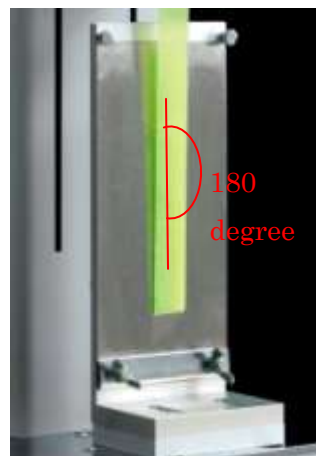

Specifications

Model	P180-200N
Peeling length	150mm at maximum
Sample width	40mm
Capacity	0.5~200N
Dimensions	Refer to dimensions
Weight	Approx.300g
Test stands available	MX-500N-L, MX2-500N-L, MX-1000N-L, MX2-1000N-L, EMX-1000N-L

* Contact us in case using with other models of test stand.



* Special adapter is required to fix EMX-1000N-L

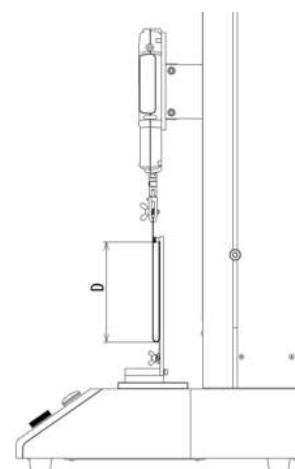

* Force gauges, test stands, optional attachments are sold separately.

Peeling length

Test stands	Peeling length D
MX2-500N-L	Approx. 7mm
MX2-1000N-L	15mm (Full length of peeling table)
EMX-1000N-L	150mm (Full length of peeling table)
MX-500N-L	Approx. 120mm
MX-1000N-L	15mm (Full length of peeling table)



Option	
Weight roller APR-97 (Meets JIS Z0237:2000)	Spare stainless panel SSP-1608
	
It helps to stick samples on the panel with stable force, which leads stable measurement result. (Meets JIS Z0237)	Needless to take off and wash the panel after every measurements, if you have spare panel. It helps save time and work.

Related products		
90 degree peeling fixture P90-200N	Fixture for film sticking test TKS-250N/TKS-20N	180 degree peeling tester IPT200-5N/20N/50N
90 degree peeling test of tape with P90-200N 	Sticking strength test of film with TKS-250N 	Exclusive for peeling test Easy to handle and set up samples 

*Force gauges, test stands, optional attachments are sold separately.

[Dimensions]

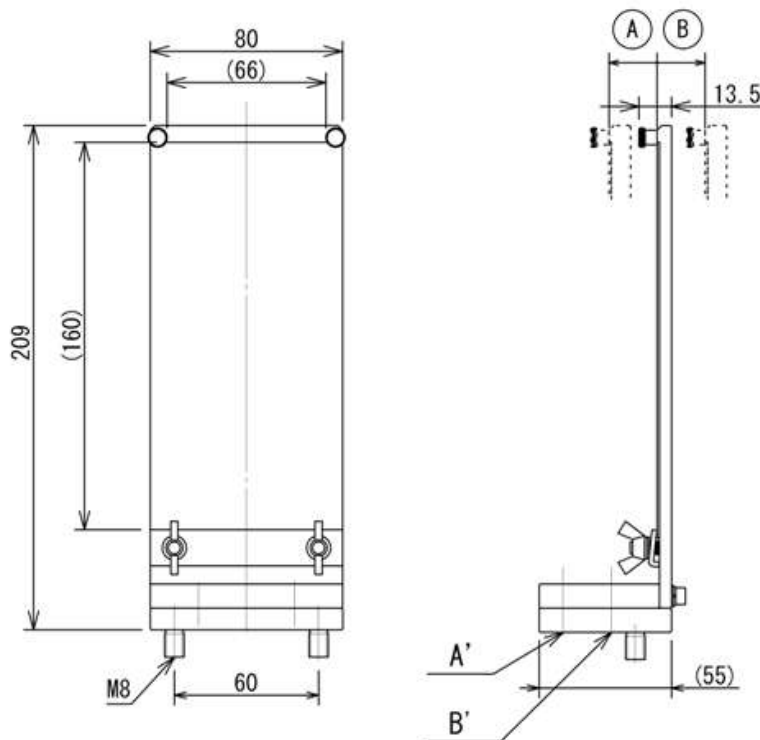

Ⓐ	+20mm	To set position A'
Ⓑ	-20mm	To set position B'

[Caution]

- The contents may be changed without previous notice.
- All of products are designed for measurement purpose only.
- Force gauges, test stands, optional attachments are not included but necessary to carry out tests.
- Some sample cannot be measured depending on their materials or shapes.
- Do not copy and use this content without authority.

Please feel free to contact us for measurement solutions, distributor's information in your country, and so on.

TEL: +81-(0)532-33-3288
 Email: info@forcegauge.net