

Texture Analyzer FRTS

- FRTS quantifies texture in force (N/kgf/lbf) to evaluate the textural properties of food.
- Simple operation: Simply choose desired food (your test sample) or a test standard from the list on its touch screen, then it shows recommended measuring conditions.
- Test results can be confirmed graphically using included software.

[FRTS series]

- ◆ Simple operation by a touch screen



- ◆ Designed to combine a wide range of attachments (probes) to fit your test samples, and change them very easily.



《Calibration Certificate》







Optionally if you need, we can offer calibration certificate or traceability chart complying with Japan national standards.

*It is calibrated to force.



[Applications]

Butter	Beef (raw)	Egg (raw)	Cooked rice (Clump)	Rice gruel Universal design food
				
Shear	Shear	Compression	Compression	Compression

*Designed to conduct a wide range of food measurement changing attachments (probes).

[Features]

1. Simple operation
2. Easy data management and analysis
3. Easy care

Feature 1	<p>Simple operation:</p> <p>Simply choose desired food (your test sample) or a test standard from the list on its touch screen, then it shows recommended measuring conditions.</p>
------------------	--

FRTS offers 3 methods to set up measuring conditions to fit your measuring needs.

«Method 1: Select food to confirm measuring conditions»

Choose "Food/Standard."	Select your test sample from Food list.	Mount the specified attachment. (Specified attachment is indicated on its screen.)	Put a test sample on a table.
Recommended measuring conditions are indicated.	Max.6 conditions can be added to Favorite.	Start measurement.	Measured results are indicated.

Point The recommended (preset) conditions can be edited as required, and add the conditions to Favorite. The conditions can be recalled very easily from Main menu.

▪ **Food list** (This is excerpted version.)

Choose one from this list.

If you do not find desired food, please select a similar food or the food whose shape is similar to your sample.

Sweets	Japanese sweets	Dairy products	Butter	Noodles	Bread	Rice	Meat
Cake, pie, jelly, snack	Manju, rice cracker	Cheese, yoghurt	Butter	boiled noodles, Noodle dough	Bread, donut, kneaded dough	Uncooled rice, cooked rice	Raw meat, cooked meat
Fish and seafood	Paste	Beans	Nuts	Eggs	Vegetables	Mushrooms	Fruits
Cooked fish, raw fish	Fish sausage, paste	Cooked bean, tofu	Peanut	Egg shell, raw egg, boiled egg	Carrot, Cucumber, pepper, potato	Mushroom	Apple, Grape, jam

Point We can add 1 program according to your request (some measuring conditions are not acceptable). Please make sure to tell us before you order (Free of charge up to 1 program).

«Method 2: Select a test standard to confirm measuring conditions»

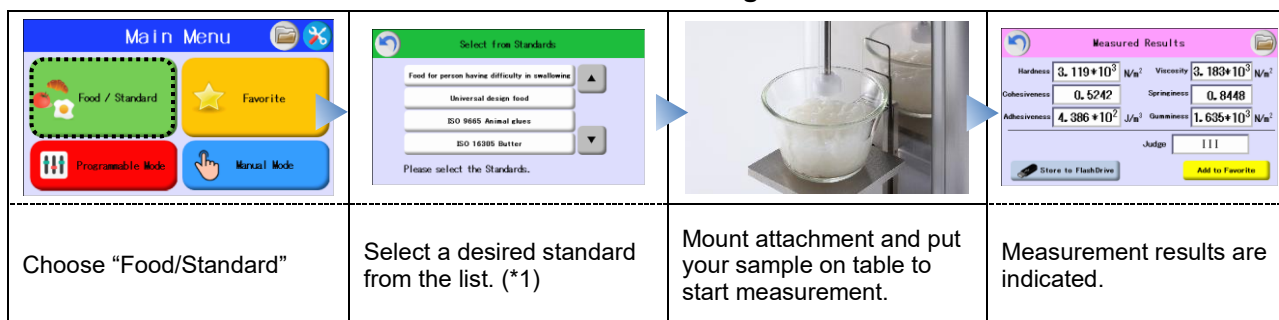

*1 To perform test complying with "Food for person having difficulty in swallowing," you need a PC and its included software to show the results. Any PC is NOT included.

•List for test standards

Standards	Outlines	Measurement results
Food for person having difficulty in swallowing	Complying with required measuring method, it measures softness, cohesive property, and adherability using included software.	3-steps judgement method (Permission Criteria I / II / III)
Universal design food	It measures firmness according to required measuring method.	4-steps judgement method (Able to chew easily / able to smash with gum / able to smash with tongue / able to swallow without chew)
JIS K6503 Animal glues and gelatins	It measures firmness according to required measuring method.	Force value (N)
ISO16305 Butter	It measures firmness according to required measuring method.	Force value (N)
ISO9665 Animal glues	It measures firmness according to required measuring method.	Force value (N)
Formar JAS Special packaging for Kamaboko and the like	It measures firmness according to required measuring method.	Force value (N)



We can add 1 program conforming to your necessary standard (some measuring conditions are not acceptable). Please make sure to tell us before you order (Free of charge up to 1 program). *

«Method 3: Manually set up measuring conditions»

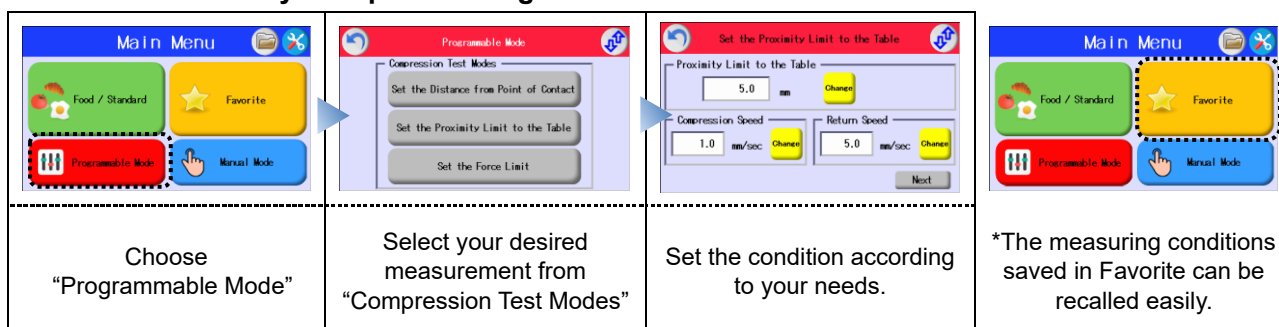

Max.6 conditions can be added to Favorite.

Feature 2 **Easy data management and analysis:**
USB flash drive* and software* enable you to manage data easily. *They are included.

•Store data into USB flash drive.



•Insert included USB flash drive into the controller.

•Touch this button
 to store data into the USB flash drive.

•Software shows test results graphically.

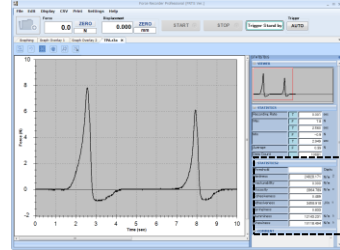

Threshold	24628.171	N/m
Fracturability	0.000	N/m
Viscosity	2864.788	N/m
Cohesiveness	0.489	
Adhesiveness	3450.910	
Springiness	0.883	
Stiffness	12143.231	N/m
Stress	10718.824	N/m

•It calculates various types of textures.

- It draws force-displacement or force-time graph.
- It draws graph in real time at Max. 1000Hz.
- Max.5 graphs can be overlaid.

•Compare force distribution visually.

e.g.) Hamburg steak shear test

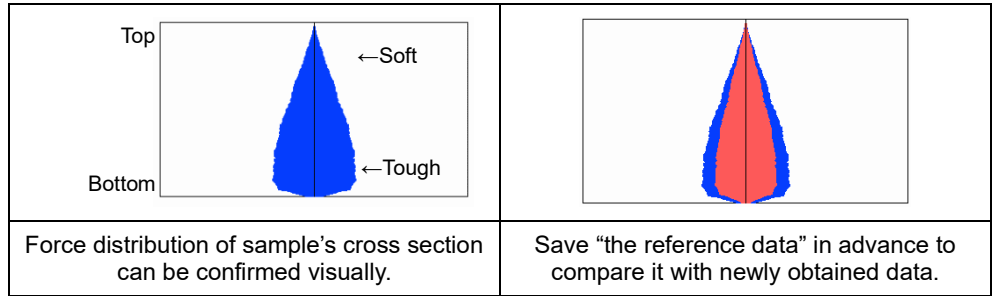

Feature 3 **Easy care:**
Designed to keep clean.

Around the measuring part is stainless material.



The table and tray are removable.



[Specifications]

Model		FRTS-5N	FRTS-50N	FRTS-100N
Capacity		5N	50N	100N
Resolution		5.000N	50.00N	100.0N
Accuracy	Force	±0.2%F.S±1digit		
	Displacement	0.1mm±1digit		
Unit	Force	N / Kgf / lbf (*)		
	Displacement	mm / inch (*)		
Indication	Force	4-digit		
	Displacement	0.001mm (as the minimum resolution)		
Sampling rate		1000Hz		
Sample maximum height		70mm(*1)		
Table travel distance		Max.100mm		
Speed		0.1 to 10.0mm/sec		
Functions		3 types of measuring method (Food/Standard(*2), Program, Manual), Add-a-favorites for measuring conditions (Max.6 conditions), Start-trigger function, Overload preventing function (*3)		
Output		USB, USB flash drive		
Accessory		Graphing software, Power cable, USB cable, USB flash drive, Attachment (4 kinds), FR-HN (screw for mounting lower tension attachments), FR-JS-50/100 (2 type shafts for mounting upper attachments), Fuse, Inspection certificate		
Operating environment (*4)		Temperature: 0 to 40 degree Celsius Humidity: 20 to 80 %RH		
Weight		Body: 7.7kg Control Panel: 0.8kg		
Size		185 x 300 x 400 mm (except its control panel)		

* The units are switchable. The units differs from Japanese domestic model.

*1 It is the maximum distance from its table surface to the part where an attachment is mounted.

*2 PC for measurement is required to comply with some standards. *3 You cannot prevent overload in some cases.

*4 Not able to use this product in a vibratile environment.







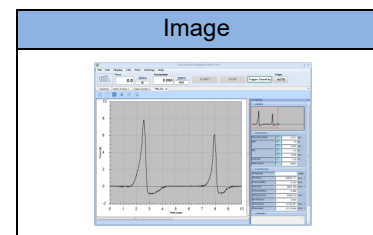

[Accessory]

- Graphing software: Force Recorder Professional(FRTS Ver.)

Operating environment	Windows 8.1/10/11
Hardware	CPU: 1GHz or higher recommended Memory: 2GB or more recommended Hard Disk: 10GB (Data Storage Area) or more
Plat form	.NET Framework 4.8 or later
Connection port	USB1.1, USB2.0 connector *We do not guarantee operation in USB3.0.



- 4 attachments

FRTS-5N and FRTS-50N			
Disk probe FR-HA-20J	Conical probe FR-ES-60-20J	Wedge probe FR-KS60-2030J	Sphere probe FR-SR-20S
			
FRTS-100N			
Disk probe FR-HA-20S	Conical probe FR-ES-60-20S	Wedge probe FR-KS60-2030S	Sphere probe FR-SR-20S
			

[Related Products]

•Optional attachments exclusively for FRTS

For compression test	For tension test	For shear test	Tables
We offer a wide range of shapes such as disks, sticks, needles and the like.	Designed for tensile tests of film, noodles, and so on.	Designed for shear tests. Knife or wedge shaped.	A table to hold containers

*These attachments above are NOT included in FRTS.

*Please refer to each specifications for detail.

*We can custom design and manufacture to meet your particular requirements.

[Dimensions]

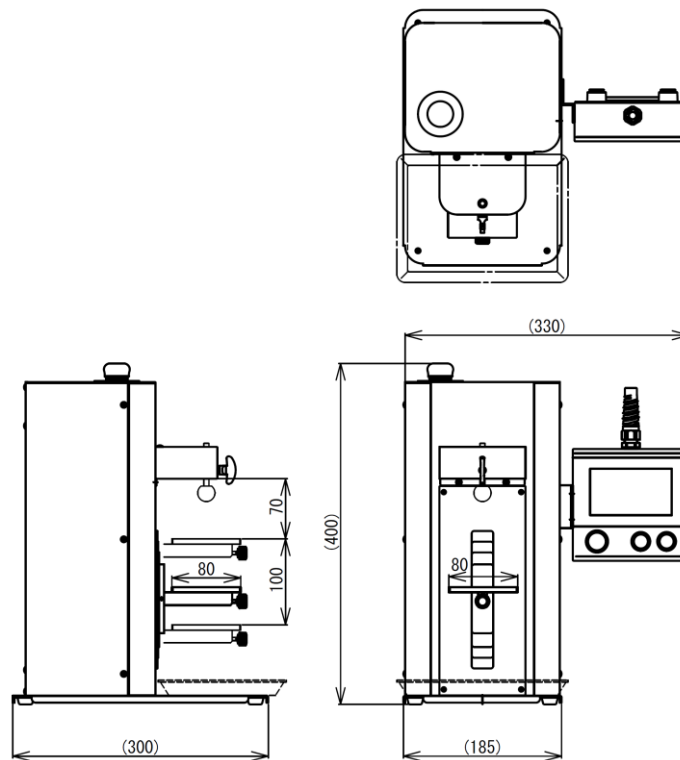

Unit: mm

[Cautions]

- The contents may be changed without previous notice.
- All of products are designed for measurement purpose only.
- Do not copy and use this content without authority.
- Please note that the capacity is dependent on the displayed unit. Please contact us for details.

IMADA CO., LTD

99 Jinnoshinden-cho aza Kanowari Toyohashi
Japan 441-8077

Tel: +81-(0)532-33-3288

Fax: +81-(0)532-33-3866

E-mail: info@forcegauge.net

Website: <https://www.forcegauge.net/en/>



Visit our website for more information on wide product specifications, measurement applications and videos.