

High Capacity Compression Jig SP Series (Spherical type)

Ideal for high capacity compression / breaking test up to 5000N.
Suitable for compressing varieties of samples, including cushioning materials.



SP-5030



SP-5010 Testing Image

Installing jig for testing		
Fix the jig to the force gauge	Set the sample	Compress to measure

Specifications			
Model	SP-5010	SP-5020	SP-5030
Capacity	5000N		
The external diameter of sphere	φ10mm	φ20mm	φ30mm
Dimensions	See [Dimension]		
Weight *1	Approx. 26g	Approx. 55g	Approx. 135g
Mounting thread	M10		

*1 Weight of the attachment is also applied as a load on the force gauge. Consider it when selecting the capacity of a force gauge.



Examples of Product Configuration SP-5030	
<p>Example 1 Code: 1S2004A For functional and versatile testing up to 5000N</p> <p>Digital Force Gauge: ZTS-5000N Motorized Test Stand: MX2-5000N Optional Attachment: SP-5030 Optional Cable: CB-528 *1</p>	 <p>SP-5030 Example 1 Image</p>

* Refer to specifications of each product for details.

* Product configuration varies depending on the shape and characteristic of the sample, and measurement conditions.





* The recommended capacity of force gauge varies depending on the expected force to be loaded.

*1 Durability test with predetermined force and time can be activated by using optional cable.

Mountable Force Gauge	
High Capacity ZTS/ZTA series	PSH series
Digital force gauge with high precision, featuring high sampling rate and a variety of useful functions.	Mechanical force gauge for easy handling.
	

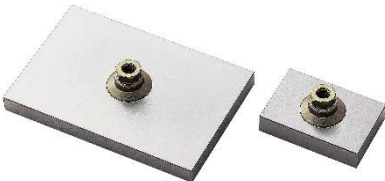
* Refer to specifications of the individual product for details.

* Select suitable force gauge to correspond with the mounting screws of attachment.

Related Products		
High Capacity Compression Jig [Disc type] PC series	High Capacity Compression Jig [Rectangle type] SQ series	Durability Test Fixture PR-500N/2500N
Ideal for high capacity compression/ breaking testing up to 5000N. They can contact a test samples closely due to a free joint design.	Ideal for high capacity compression/ breaking testing up to 5000N. They can contact a test samples closely due to a free joint design.	Ideal for durability tests for retort pouch, heat sealed package, up to 2500N.
		
Conversion Adapter CA series	Urethane Spherical Compression Jig UR series	
For mounting a M10 screw attachment to a M6 screw thread of a force gauge.	For finger pressed image tests, up to 50N.	
		

* Refer to specifications of the individual product for details.

[Custom made solution]

We offer custom made options including change of diameter, materials (stainless only) and other options. Please contact us for details.

[Dimension]

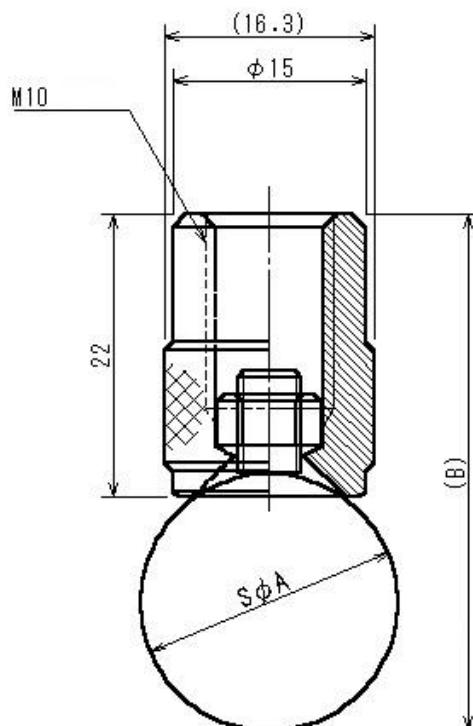

Model	A	B
SP-5010	10	30
SP-5020	20	40
SP-5030	30	50

Unit: mm

[Cautions]

- Information in this document is subject to change without prior notice.
- This document is product descriptions and handling precautions, and do not guarantee various characteristics or safety.
- This product is designed for force measurement purpose only.
- Do not copy and use this content without authorization.
- A force gauge (sold separately) is required to use this product.
- Some samples may not be suitable to measure with this product.

IMADA CO., LTD.

99, Jinnoshinden-Cho, Aza, Kanowari, Toyohashi,
Aichi 441-8077, JAPAN
Tel: +81-(0)532-33-3288
Fax: +81-(0)532-33-3866
E-mail: info@forcegauge.net
Website: <https://www.forcegauge.net/en/>



Visit our website for more information on a wide range of product specifications, measurement applications and videos.