









## Torque Gauge/ Motorized Torque Stand Attachments

Exchangeable attachments for Torque Gauges. It helps various torque measurement such as screws, bolts and the sample durability.

[Compatible Model List]

Compatible Torque gauge Attachment	HTGA/HTGS/eH T series 	DTXA/DTXS series 	MTS series Upper 	Sample Examples
 To page 3	Large:HT-DC-13 Medium:HT-DC-6.5 Stainless-steel Medium: HT-DC-6.5SUS Small:HT-DC-4	Large: DT-DC-13 Medium: DT-DC-6.5 Stainless-steel Medium: DT-DC-6.5SUS Small: DT-DC-4	Large:MT-DC-13 Medium:MT-DC-6.5 Stainless-steel Medium: MT-DC-6.5SUS Small: MT-DC-4	Stranded wire, Electronic component sliding torque etc.
 To page 4	HT-9.5SQ	N/A	N/A	Bolt tighten/ loosen torque etc.
 To page 5	HT-DBH	N/A	N/A	Screw tighten / loosen torque etc.
 To page 6	N/A	N/A	MT-TB	Screw-cap torque test, Circuit board twisting test etc.
 To page 7	HT-AD-M10	N/A	MT-AD-M10	An adaptor for mounting jigs

➤How to mount the attachment

**HTGA/HTGS/eHT series**



Prepare the attachment

➡



Insert the attachment

➡



Turn screw by attached L wrench

**DTXA/DTXS series**



Prepare the attachment

➡



Insert the attachment

**MTS series (the upper chuck attachment)**

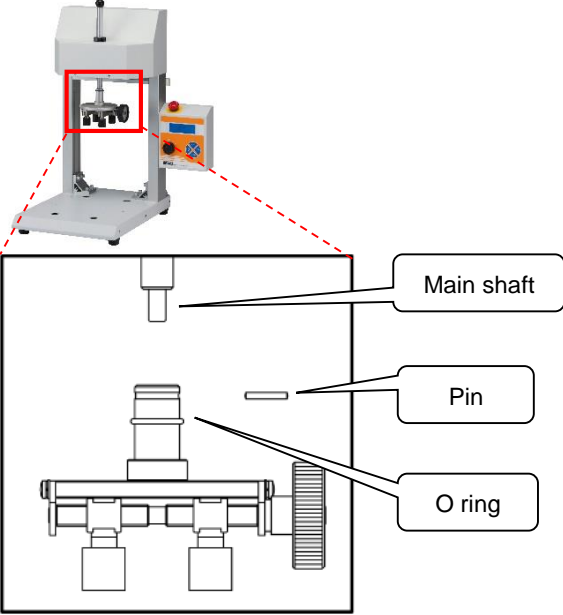

The diagram shows a cross-section of the upper chuck attachment. A red box highlights the main shaft area. Labels with leader lines point to the 'Main shaft', 'Pin', and 'O ring'.

**Mount the suitable chuck attachment for the measurement needs**

1. Move the included main shaft in MTS series to the place the user works smoothly.
2. Move the O ring of the attachment and extract the pin.
3. Insert the attachment at the tip of main shaft and insert the pin extracted at Step 3.
4. Back the O ring to the first position.

**We accept custom-orders of creating original attachments for the sample.**

□ Pin chuck

	Feature
	The three claws clamp samples such as wire and round-bar samples.

[Model list for HTGA/HTGS/eHT series]

Model	HT-DC-4	HT-DC-6.5(*1)	HT-DC-6.5SUS(*1)	HT-DC-13(*2)	Mount on HTG series sensor part.
Maximum torque	5N-m	10N-m	10N-m	10N-m	
Opening width	φ0.5mm~4mm	φ0.5mm~6.5mm	φ0.5mm~6.5mm	φ1.2mm~13mm	
Weight	Approx.100g	Approx.200g	Approx.190g	Approx.600g	
Material	Steel	Steel	Stainless-steel(*3)	Steel	

[Model list for DTXA/DTXS series]

Model	DT-DC-4	DT-DC-6.5	DT-DC-6.5SUS	DT-DC-13	Mount on DTX series.
Maximum torque	5N-m	10N-m	10N-m	10N-m	
Opening width	φ0.5mm~4mm	φ0.5mm~6.5mm	φ0.5mm~6.5mm	φ1.2mm~13mm	
Weight	Approx.190g	Approx.290g	Approx.290g	Approx.670g	
Material	Steel	Steel	Stainless-steel(*3)	Steel	

[Model list for MTS series]



Model	MT-DC-4	MT-DC-6.5	MT-DC-6.5SUS	MT-DC-13	Mount on MTS series upper side.
Maximum torque	5N-m	10N-m	10N-m	10N-m	
Opening width	φ0.5mm~4mm	φ0.5mm~6.5mm	φ0.5mm~6.5mm	φ1.2mm~13mm	
Weight	Approx.170g	Approx.270g	Approx.270g	Approx.650g	
Material	Steel	Steel	Stainless-steel(*3)	Steel	

\*1 HT-DC-6.5 and HT-DC6.5 SUS cannot be used for HTGS/HTGA /eHT-0.5N.

\*2 HT-DC-13 cannot be used for HTGS/HTGA /eHT-0.5N or 2N.

\*3 We recommend to use the stainless-steel chuck under the circumstance making metal rust.

Using image (Example: HTGA/HTGS/eHT series)

 <p>Step 1: Mount the pin chuck on the torque sensor.</p>	 <p>Step 2: Hold the sample. Turn the sleeve and tighten the sample with the included chuck key.</p>	 <p>Step 3: Twist the holding sample and measure the torque.</p>
--	--	---

[Dimensions]

HT-DC-4

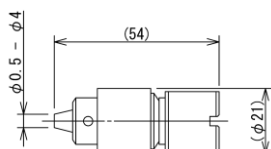

HT-DC-6.5/HT-DC-6.5SUS

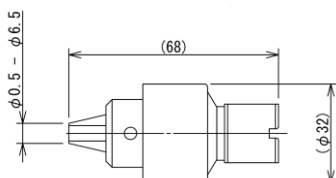

HT-DC-13

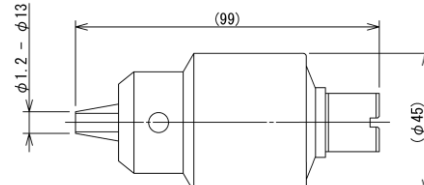

Unit: mm

DT-DC-4

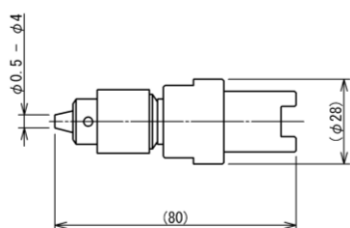

DT-DC-6.5/ DT-DC-6.5SUS DT-DC-13

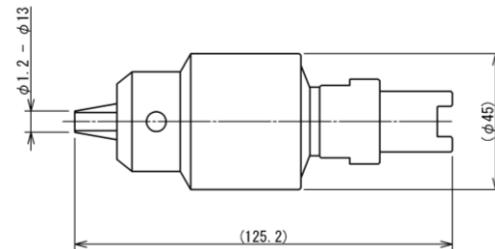
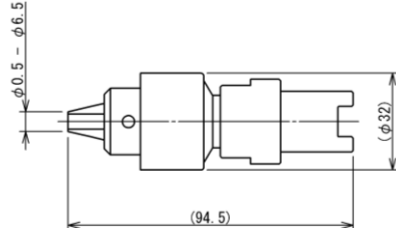

MT-DC-4

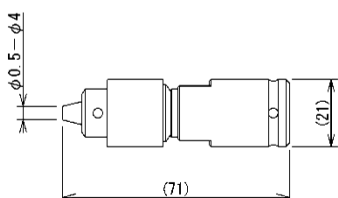

MT-DC-6.5/MT-DC-6.5SUS MT-DC-13

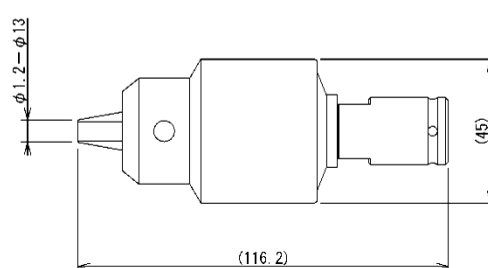
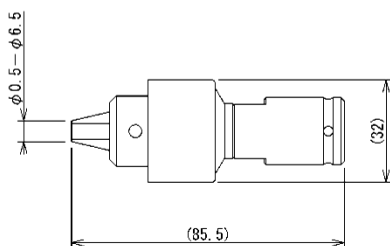

□ Socket holder HT-9.5SQ



Feature

Varieties of torque measurements using a tool such as a screwdriver bit and a wrench are possible.

Using image



Step 1: Prepare a 9.5mm square socket wrench.



Step 2: Mount the socket wrench on the socket holder.



Step 3: Mount the Step 2 socket holder on the torque sensor.

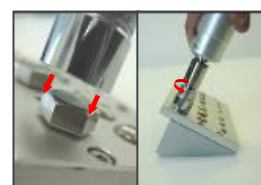

Step 4: Twist a bolt with the socket wrench and measure the torque.

[Model list for HTGA/HTGS/eHT series]

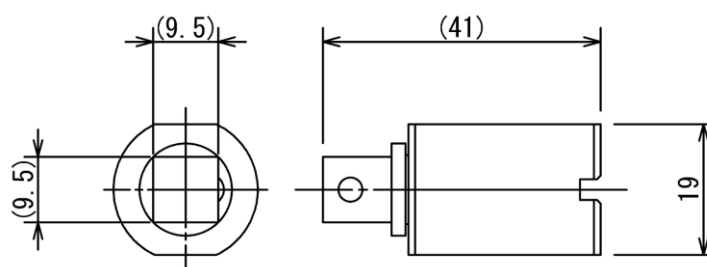

Model	HT-9.5SQ
Socket	9.5mm square

[Dimension](unit: mm)



□ Torque driver HT-DBH

	<b>Feature</b>
	Measure tighten and loosen screw torque with the included screwdriver bit.

How to use		
Insert the driver bit to the torque driver tightly.	Mount the torque driver to the torque sensor.	Twist a screw and measure the torque.
		

[Model list for HTGA/HTGS/eHT series]

Model	HT-DBH
Included screwdriver bit	⊕1⊕2⊕3x⊖6x45mm
Weight	Approx.100g

[Dimension] Unit: mm

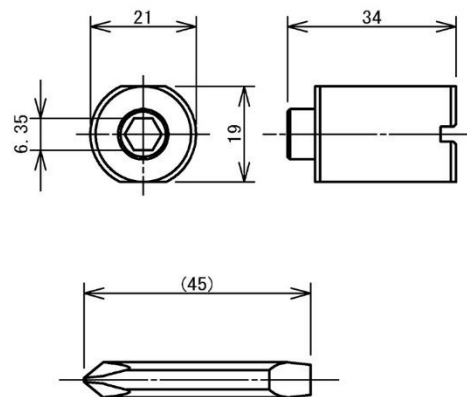



□ Standard chuck ( for MTS series)

Standard chuck (including the pins)	Feature	Model
	Holds the sample with stable force by using a torque driver. Capacity: 10N-m Allowable sample diameter: $\phi 20\text{mm} \sim \phi 90\text{mm}$	MT-TB

\*Please feel free to contact us when you need to purchase only the pins. (+81- (0)532-33-3288)

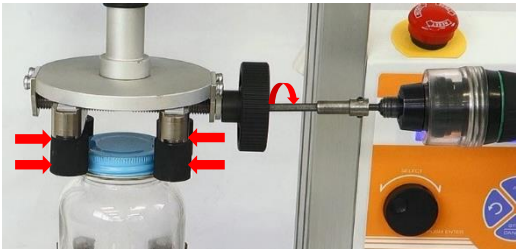
\*A torque driver is NOT included.

Stable holding force by using with a torque driver	Using image
 <p>The high repeatable measurement is possible by fastening the M5 screw at the center of the handle to keep the holding force stably.</p>	 <p>Opening test of a bottle (Using MTS series)</p>

[Dimension] (Unit: mm)

[MT-TB](Standard chuck for MTS series)

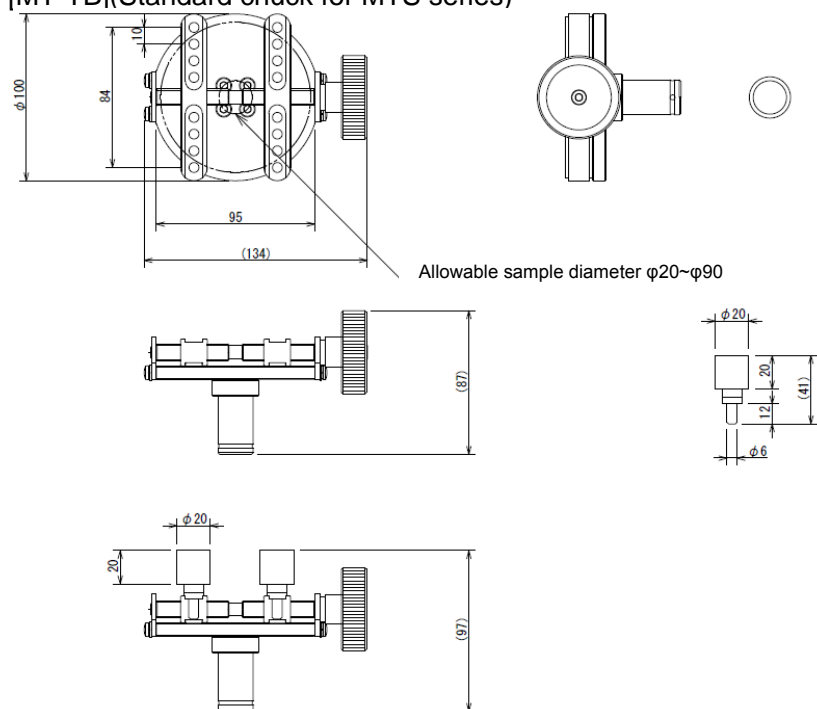

The dimension at mounting the pins

□M10 adaptor

	<b>Feature</b>
	The adapter for mounting an original jig by the customers. The customers can use their own jig to measure torque.

[Model list for HTGA/HTGS/eHT series]

Model	HT-AD-M10
Screw	M10xL20
Weight	Approx.50g

[Dimension]

Unit: mm

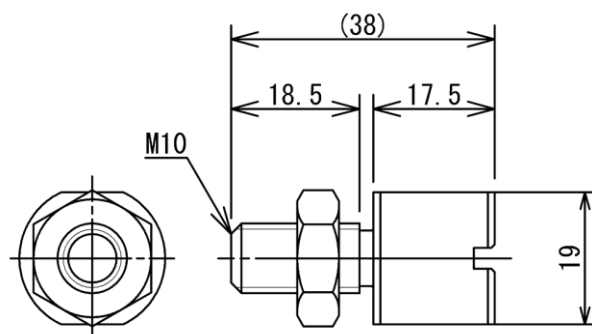

[Model list for MTS series]

Model	MT-AD-M10
Screw	M10xL20
Weight	Approx.50g

\*The upper side attachment of MTS series

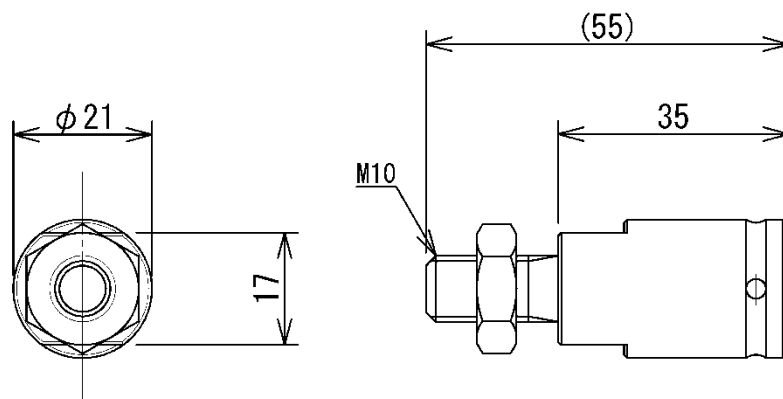

**[Cautions]**

- The contents may be changed without previous notice.
- All of products are designed for measurement purpose only.
- Do not copy and use this content without authority.
- Please note if you add load over capacity, its sensor would be broken down.

**IMADA CO., LTD**

99 Jinnoshinden-cho aza Kanowari Toyohashi  
Japan 441-8077  
Tel: +81-(0)532-33-3288  
Fax: +81-(0)532-33-3866  
E-mail: [info@forcegauge.net](mailto:info@forcegauge.net)  
Website: <http://www.forcegauge.net/en/>



Visit our website for more information on wide product specifications, measurement applications and videos.