

Motorized test stand EMX series EMX-500N/1000N

- High end model achieving greater precision as well as high usability
- Wide speed range, 0.5 to 600mm/min, allowing various test conditions
- Able to press and pull sample at desired distance from contact point (Length limit/Contact detection)

Improving precision of measurement with EMX series

EMX feature rugged design and smooth motion, achieving precise measurement. With minimized influence of deformation, it is not only suitable for force measurement, but also a perfect solution for force-displacement measurement. Combine it with a force gauge and dedicated software, to draw graphs of force vs time or force vs. displacement at high sampling rate (2000Hz).

It equips useful functions to handle a variety of testing, such as wide speed range (0.5 to 600mm/min), setting of digital travel distance by 0.1mm, contact detection, repeating number of testing, pausing time, and operation pattern storing functions. Furthermore, the equipped I/O connector allows communications with various external devices, which can be used to improve efficiency or safety in testing by using inputs such as start and interlock.



EMX-500N

EMX-1000N

Features

<p>Highest Repeatability</p> <ul style="list-style-type: none"> · Applies constant testing speed and direction · Most rugged design minimizing influence of deformation (max. 0.25mm) · Smooth motion by ball screw mechanism · Digital setting of travel distance by 0.1mm 	<p>Easy Operation</p> <ul style="list-style-type: none"> · Easy set-up mode · Ergonomically inclined control panel · Dial operation for digital setting · 4 testing modes to meet testing requirements
<p>Versatility for a wide variety of testing</p> <ul style="list-style-type: none"> · Wide speed range from 0.5 to 600 mm/min · Ideal for durability test by setting the number of test cycles · Timer function for compression testing allows pausing at a set force value (*1) · Designed for mounting a wide range of grips and fixtures · External signal input is equipped 	<p>Functions improving test efficiency</p> <ul style="list-style-type: none"> · Automatically detects contact point (*1) · Up to 5 testing patterns can be stored or copied · Automatically changes traveling and measuring speed at a set force value (*1) · Starts software together with test stand motion (*1) · Stops motion when it sense that test sample is broken (*1*2)

*1 Requires certain models of force gauge and optional cable.

*2 This function is not able to be used together with contact detection.

[Application Example and Configurations]

[Optional Cable]
Connects force gauge and test stand to activate a variety of control functions.

[Force Gauge]
Measures compression, tensile, peel strength, etc. Mountable to test stand with screws.

[Optional Attachments]
Integral components to complete a testing system, selectable from a wide range to suit your testing applications.

[Stroke Limit]
[Speed Shift Point]
Set limits of stroke easily with upper and lower knobs. Middle knob adjusts the speed shift point.

[Head]
Operates upward and downward with mounted force gauge.

[Table]
Attachments or testing samples can be mounted on the table.
Dimension: W200 x D100 mm

[Operation Panel]
Used for settings, operations and emergency stop.

*Force gauge, optional attachments and optional cable are sold separately.

[Operation Panel]



[Emergency Button]
For emergency stops

[Push Dial]
For setting by turning and pressing. Jog move at manual mode.



[LCD]
Shows status and settings

[Operation Buttons]
Controls upward and downward at set/max. speed and stop.

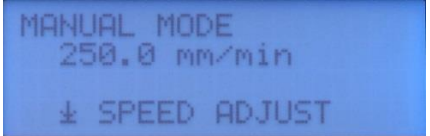

[Applications] Use suitable attachments to perform a variety of measurements.

Tactile test of switches	Material bend testing	Repulsion test of cushion material
Evaluates tactility of a variety of switches and buttons such as a switch of camera shutter.	Applies compression force to test strength of materials such as metal by bending or breaking.	Analyzes cushioning characteristics of materials including sponges and packaging buffers.
		

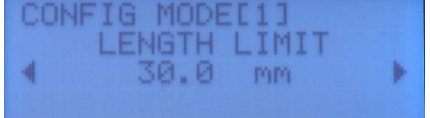
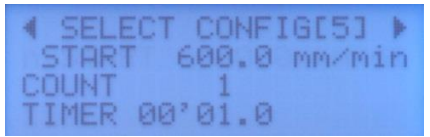
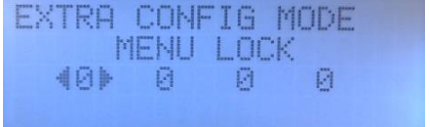
[Basic Operations]

<p>Adjusting speed</p>		<p>Testing speed is easily adjustable with dial.</p> <p>Setting resolution: [0.5-20mm/min: 0.5mm/min] [20-100mm/min: 5mm/min] [100-600mm/min: 10mm/min]</p> <p>Adjustable speed types: Start, Measuring, Return</p>
<p>Three measuring modes</p>		<p>Three testing modes are available to meet requirements.</p> <ul style="list-style-type: none"> - Manual mode: Moves while up/down buttons are pressed - JOG mode: Minute feeding by turning dial (approx. 0.01mm per 1 turn) - Cycle mode: Travels between stroke limit knobs for cycles (Available from ONE WAY STOP, AUTO RETURN, REPEAT CYCLE and KEEP LOAD)
<p>Other functions</p>		<p>Timer and Counter: Allows to set the number of tests to repeat and pausing time</p> <p>Counter (number of tests to repeat): Max. 65535 times Timer (pausing time): Up to 99 min 59 sec 9 (by 0.1 sec)</p>
		<p>Digital length limit: Moving distance set by digital setting</p> <p>Digital displacement limit: by 0.1mm</p>
		<p>Storing operating patterns: Up to 5 patterns of testing speed, counter, timer, and digital displacement limit stored as operating conditions</p> <p>Copy and edit the set conditions improving workability of editing the conditions</p>
		<p>Menu lock: Set a password to prevent accidental changes of measurement conditions</p>

[Main Options]

<p>Long stroke (-L)</p>	<p>-FA option (-FA)</p>
<p>This option provides extended stroke. Useful when testing stretching samples or testing for long distance.</p>	<p>This option provides inbuilt liner scale. It allows displaying displacement data on force gauge together with force value and drawing FS curves in PC via USB. *ZTA series force gauge and optional cable are required. *Force-displacement measurement unit FSA series are also available, which includes the necessary products.</p>
	

[Specifications]

Model	EMX-500N	EMX-1000N
Capacity	500N	1000N
Speed	Digital 0.5 to 600mm/min [0.5 - 20mm/min: by 0.5mm/min] [20 - 100mm/min: by 5mm/min] [100 - 600mm/min: by 10mm/min]	
Max. Sample Height *1	300mm	320mm
Rigidity	[Standard models] less than 0.25 mm [Long stroke (optional)] less than 0.6 mm	
Stroke Limit	Controllable with upper and lower knob Digital length limit (travel distance)	
Measuring Modes	Manual / Jog / Cycle mode	
Functions	Counter (number of tests to repeat): Max. 65535 times Timer (pausing time): Up to 99 min 59 sec 9 (by 0.1 sec) Length limit (travel distance): by 0.1mm Storing operating patterns: up to 5 patterns Contact detection (*2*3), Break detection (*2*3) Easy Setup (simple operating mode selection) Copy (operating condition duplication) Menu lock (menu protection lock)	
Control	Emergency stop, force control (*4), overload prevention (*4, *5), external signal input	
Operating temperature humidity	0 to +40 degree Celsius 35 to 70% (avoid condensation)	
Voltage	AC100 to 240V, 50/60Hz (Select from 100, 120 and 230V. Accessories are provided accordingly.)	
Power Consumption	50W	
Dimensions	See [Dimensions]	
Weight	Approx. 18kg	Approx. 23kg
Accessories	Operating manual, power cable, spare fuse, tools, GF-1 (Grip mounting adaptor) Anti-tip fixture (only for -L option)	Operating manual, power cable, spare fuse, tools, GF-2 (Grip mounting adaptor) Anti-tip fixture (only for -L option)
Available Options *6	-L: Extended stroke by 300mm -FA: Inbuilt liner scale	
Mountable Force Gauges *7	Mechanical Force Gauge: FB, PS, PSM series Digital Force Gauge: DST, DSV, ZTS, ZTA series (up to 1000N) Load cell: DPU series (up to 500N *7)	
		Mechanical Force Gauge: PSH series Digital Force Gauge: ZTS, ZTA series (over 2500N) Load cell: DPU series (1000 to 5000N *8)

*1 Max. sample height refers to the distance between the table and the tip of force gauge measuring shaft when the head is at the top. (With up to 1000N model of ZTS/ZTA series)

*2 Force gauge ZTA series and optional cable CB-528 are required.

*3 Contact detection and Break detection are not able to be used together.

*4 Force gauge ZTS/ZTA series and optional cable CB-528 are required.

*5 It does not guarantee complete protection against overloading.

*6 Add the option code after the model name to complete the model with options.

e.g., When adding long stroke option to EMX-1000N ... Model: EMX-1000N-L

*7 Ensure to use within the capacity of force gauge and test stand regardless of the mountable models.

*8 Mounting block (sold separately) is required to mount 1000N to 5000N range of DPU series.

[User Mounted Unit]

FA version: OP-EMX-FA(-L)
It builds a linear scale into a test stand to output travel distance of a force gauge and allows to utilize it for analysis of force-displacement relations.



* Requires to mount the unit to current EMX series by yourself.

* This option is available only for firmware Ver.2.0 or later. If your test stand's firmware is earlier than ver.2.0, it has to be shipped to our factory to activate this option. Contact us for more details.

* Amplifier such as ZTA and FA Plus2 (sold separately) or software are required to record measuring value of linear scale.

* Select -FA option if the test stand with built in linear scale is required.

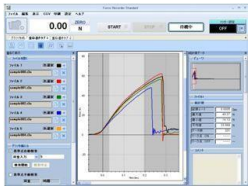
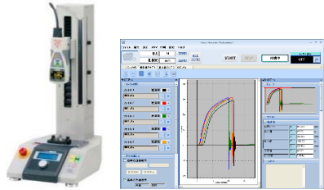
[Related Products]

Digital Force Gauge ZTS/ZTA series		Software Force Recorder series	
With high sampling rate of 2000Hz, it offers highly precise measurement. Use optional cable to control motion together with EMX series.		This graphing software can start and stop automatically based on the trigger setting of EMX test stand function.	
			
Force – Displacement Measurement Unit FSA series		Interlocking shield option for motorized test stand OP-MX2EMX-IC	
It draws a detailed graph of force and displacement, which is suitable for tactile test, material evaluation and more. The unit includes a force gauge, a test stand with a linear scale, a cable, and a graphing software.		This shield prevents debris of test sample from scattering, and stops operation when the door is open for more safety.	
		 Mounting image	
Cable	CB-528	For connecting with force gauge ZTS/ZTA series: Activates useful functions	
	CB-706	For –CN option: Open end cable to connect with external device	
	CB-728	For –FA option: Connects ZTA series force gauge and test stand to provide force and displacement measurement. (Motion control and related functions are also available.)	



[Control Functions] Activated when ZTS/ZTA series force gauge and CB-528 are used together.

<ul style="list-style-type: none"> • Overload prevention: Prevents the sensor from getting damaged due to overloading (It does not guarantee complete protection against overloading.) • Force control: Allows to set a force value to apply or to stop • Measuring speed setting: Enables automatic speed change at a point of contact using the set force value • Automatic measurement: Software recording and zeroing force gauge can be automatically done • Contact detection: Automatically detects the contact point of a sample (*1) • Break detection : Automatically detects the break of a sample and stops moving of force gauge (*1)

* Refer to 'Advanced Functions of Test Stands' for details.

*1 This function is activated only when used with ZTA series force gauge.

[Examples of Customized Solutions]

External signal input	Testing Large Samples	Controller-separated Model
Mount a switch such as a foot pedal to start and stop operation, which improves efficiency or allows operating it together with your equipment.	Recommended when you... - Test a sample larger than test stand table. Test multiple points on a large sample to push in/pull.	Recommended when you... - Need to incorporate IMADA testing system to your equipment - Fix controller/drive part on a specific place Need to prevent dangers in testing by keeping distance.
		

[Dimensions]

EMX-500N(-L)

EMX-1000N(-L)

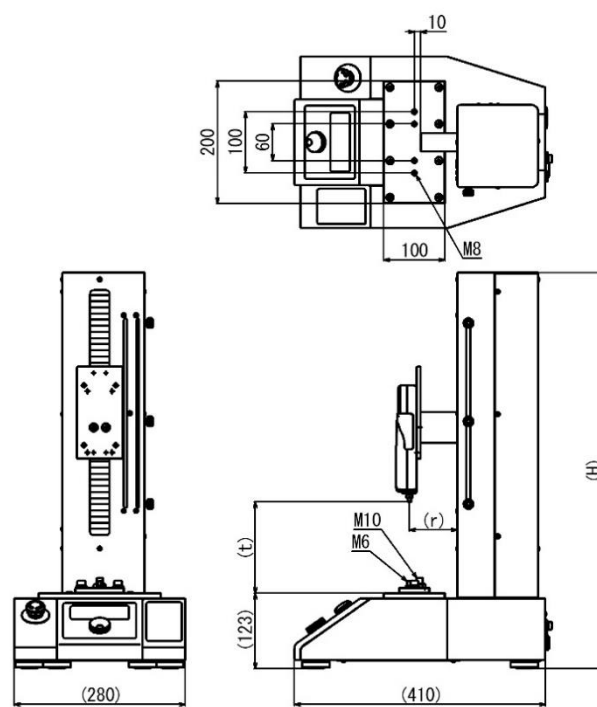
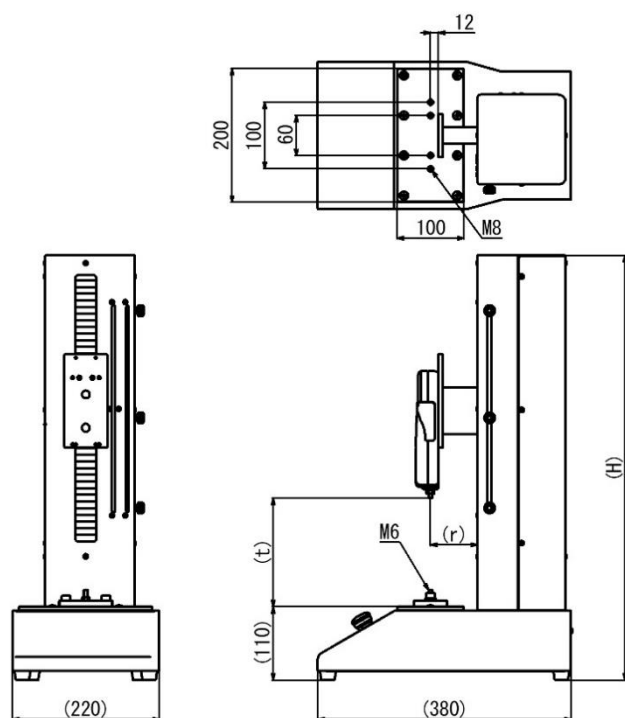

		EMX-500N	EMX-500N-L (*1)	EMX-1000N	EMX-1000N-L (*1)
H		637	937	647	948
r	DST/DSV/ZTS/ZTA (2N to 1000N) mounted	70		78	
	ZTS/ZTA (2500N to 5000N) mounted	-		91	
	DPU (up to 500N) mounted	68		76	
	DPU (over 1000N) mounted	-		80	
t	DST/DSV mounted	300	600	325	625
	ZTS/ZTA (2N to 1000N) mounted	295	595	320	620
	ZTS/ZTA (2500N to 5000N) mounted	-		365	665
	DPU (2N to 10N) mounted	415	715	380	680
	DPU (20N to 500N) mounted	410	710	375	675
DPU (1000N to 5000N) mounted (*)		-		300	600

Unit: mm

* Mounting block (optional) is required when mounting DPU-1000N to 5000N.

[Dimension when Anti-tip fixture is fixed]

EMX-500N-L

EMX-1000N-L

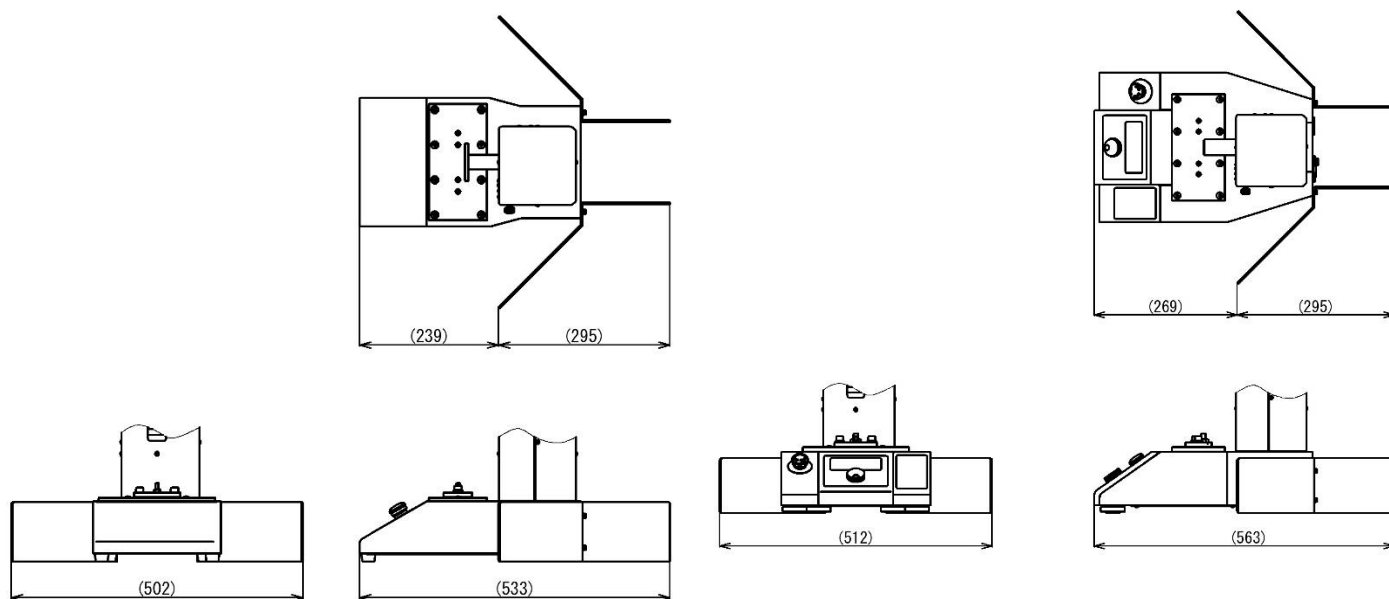

Unit: mm

* Anti-tip fixture is included in only EMX-500N-L and EMX-1000N-L.

[Cautions]

- The contents may be changed without prior notice.
- Force gauge is not included but necessary to conduct force measurement.
- This product does not include a force gauge, optional attachments or optional cable.
- This product is designed for measurement purpose only.
- Do not copy the contents without permission.

IMADA CO., LTD

99 Jinnoshinden-cho aza Kanowari Toyohashi
Japan 441-8077
Tel: +81-(0)532-33-3288
Fax: +81-(0)532-33-3866
E-mail: info@forcegauge.net
Website: <http://www.forcegauge.net/en/>



Visit our website for more information on wide product specifications, measurement applications and videos.