

Food Hardness Testing Unit FCA-DSV-50N

Feature 1: Easy compression test for a fixed distance
Feature 2: Budget lever model with high repeatability







[Test Examples]

Methods	Push in / Squash	Cut / Crack
Feature	Push in with constant area of the flat probe to test hardness of semi-solids to solids.	Measure crunchy / crispy samples by pushing with the tooth-like sharp edge.
Images	<p>Bread Jam Dough</p>	<p>Cheese Cookies Sausages</p>
Sample Examples	Processed cereal (cooked beans, bread, tofu, rice cakes) Dough (bread, noodles) Others (pudding, jam, cream cheese)	Processed meat (sausages, cutlets) Confectionary (cookies, chocolates, chewing gum) Others (cheese, pasta)
Suitable Probe	Flat probe – Push in with the flat surface <p>(Model with flat probe: FCA-DSV-50N-1)</p>	Wedge probe – Cut with the sharp edge <p>(Model with wedge probe: FCA-DSV-50N-2)</p>

[FCA series Specifications]

Two models are available to suit your requirements.

Model	FCA-DSV-50N-1	FCA-DSV-50N-2	
Capacity	50N		
Display	50.00		
Accuracy	+/- 0.2% F.S. +/- 1 digit		
Unit	N(kN), kgf(gf), lbf *1		
Stroke	0 to 45 mm (Adjustable with the limit knob)		
Maximum Space	50 to 80 mm *2		
Overload	Approx. 200% F.S.		
Power	Nickel-Metal Hydride battery (NiMH battery), USB charge(AC adapter)		
Operating Environment	Temperature: 0 to +40 degree Celsius / Humidity: 20 to 80% RH		
Functions	Peak hold(Tensile or compression)/Comparator(OK Judgement)/Sensitivity(3 steps)/ Reversible display /Sign inversion/Setting lock/Date & Time/Off timer (Auto power-off)/ Reminder for calibration schedule/Overload alarm/Tilt-sensing alarm/ Continuity peak mode/Internal memory (1000 point)		
Output	USB/RS232C		
Weight	Approx. 3kg		
Dimensions	See [Dimensions] on page 3		
Unit Details	Force Gauge DSV-50N-M4 *3 	Manual Lever Stand FCA-50N 	Others (Instruction manual, mounting screws, wrench, inspection certificate) 
Included attachment	 Flat probe (FR-HA-20J)	 Wedge probe (FR-KS-60-2030J)	
Accessories	Force Logger(Data capturing software)/USB cable/AC adaptor/Carrying case/ Instruction manual/Inspection certificate		

*1 These are the specifications for International model. Note that this unit is different from Japanese domestic model and international one.
kN is available at 1000N, gf is available at 2N and 5N ranges.

*1 The distance between the tip of the measuring shaft and the table – adjustable with the mounting position of the force gauge

*2 The measuring shaft of this model is M4 thread, which is different from standard DS2 series.

[Supplied Software : Force Logger] Using a supplied USB cable, you can easily transfer data form DSV(DST) to PC.



Features

You can easily transfer data to PC.

It automatically calculates Maximum, Minimum, and Average values.

You can save data in CSV format.

Operating environment

OS : 7/8/8.1/10 (64bit version is available)

Hardware : CPU Pentium4(1GHz more), Memory2GB, Hard disk : 10GB or more recommended



Plat form : .NET Framework4 or later

Execute environment : Internet Explorer 6.0, Windows Installer3.1 or later

Connection port : USB1.1, USB2.0 connector

[Related Products]

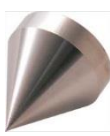
Attachments

Purpose	Push with a small area	Stick with a sharp pointed tip	Push with a ball tip
Model	Cylindrical probe FR-EC series	Conical probe FR-ES series	Sphere probe FR-SR series
Image			

* More attachments are available. Refer to optional attachments of FRT series.

* Please contact us for more information on other attachments to find out if it can be mounted.

[Other related products]

Food Rheology Tester FRT series

Food Rheology Tester FRT series



High repeatability with motorized system

Stable speed by the motor movement and the high sampling rate of 1000 data / sec achieve high repeatability in results.

Easy use by touch screen operation

It is very easy to setup the measurement conditions by selecting food menu by touch screen operation.

Meets various standards

Measurement condition at “Food for person having difficulty in swallowing”, “Universal design food” are installed and easy to comply.

Software for Analysis

The supplied graphing software enables to draw graphs to visually show the force change. Graphs can be layered to compare the differences of results.

[Dimensions]

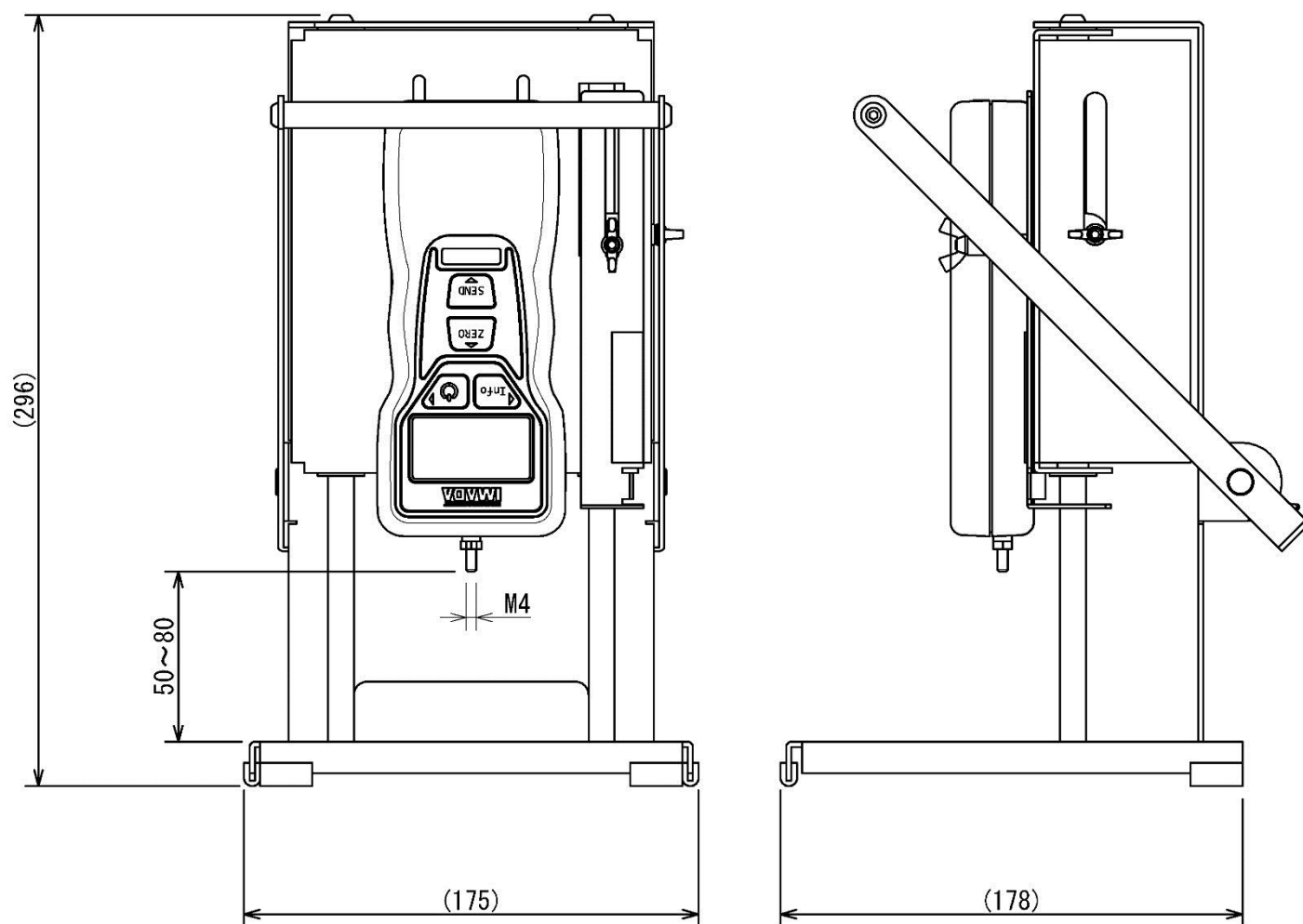

Unit: mm

[Calibration Certificate]

Calibration certificate can be issued at a charge.

[Notes]

- The contents may be changed without prior notice.
- This product is designed for measurement purpose only.
- Do not copy and use the contents without authority.
- The sensor may be damaged if it is loaded over the capacity.
- Some samples may not be correctly measured. Please contact us for any inquiries prior to purchase.

IMADA CO., LTD

99 Jinnoshinden-cho aza Kanowari Toyohashi

Japan 441-8077

Tel: +81-(0)532-33-3288

Fax: +81-(0)532-33-3866

E-mail: info@forcegauge.net

Website: <http://www.forcegauge.net/en/>



Visit our website for more information on wide product specifications, measurement applications and videos.