

Universal Joint

UJ6-1000N/UJ10-5000N

Designed to prevent unbalanced load during the measurement.
Ensures accurate measurement due to free joint design.
UJ6-1000N for M6 screw and UJ10-5000N for M10 screw are available.



UJ6-1000N



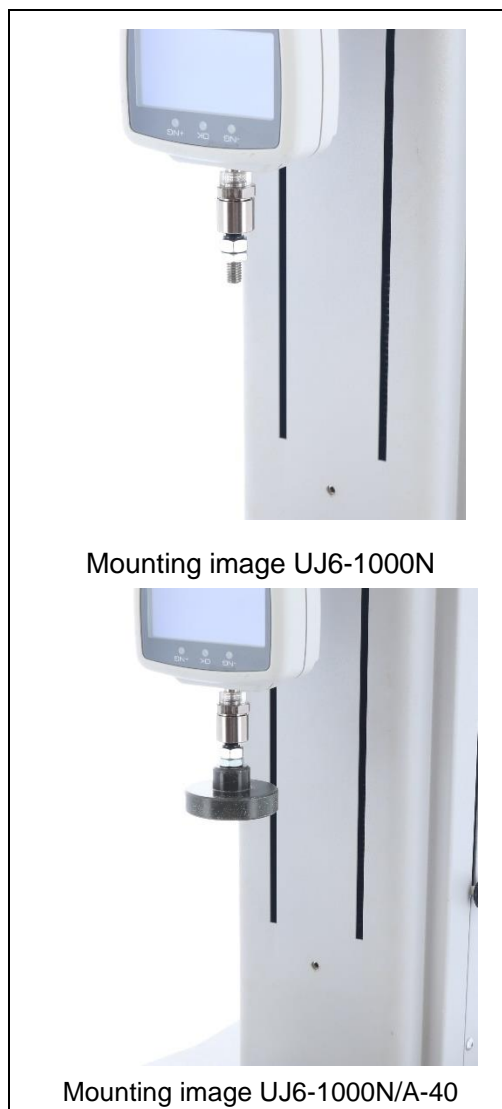

UJ10-5000N



Mounting image UJ6-1000N



Mounting image UJ6-1000N/A-40



| Installing jig for testing | | |
|---|--|---|
| Fix the jig to the force gauge | Fix the attachment on the other side | Start to measure |
|  |  |  |

| Specifications | | |
|----------------|-----------------|--------------|
| Model | UJ6-1000N | UJ10-5000N |
| Capacity | 1000N | 5000N |
| Dimensions | See [Dimension] | |
| Weight *1 | Approx. 25g | Approx. 140g |
| Mounting screw | M6 | M10 |

*1 Weight of the attachment is also applied as a load on the force gauge. Consider it when selecting the capacity of a force gauge.



* The stroke of the test stand will be decreased after mounting the attachments. Consider it when selecting attachments.

| Mountable Force Gauges for UJ6-1000N | | |
|---|--|---|
| DST/DSV series | ZTS/ZTA series | FB/PS/PSM series |
| Digital force gauge with excellent cost-performance capable to manage data with PC. | Digital force gauge with high precision, featuring high sampling rate and a variety of useful functions. | Mechanical force gauge for easy handling. |
|  |  |  |

| Mountable Force Gauges for UJ10-5000N | |
|--|--|
| High Capacity ZTS/ZTA series | PHS series |
| Digital force gauge with high precision, featuring high sampling rate and a variety of useful functions. | Mechanical force gauge for easy handling. |
|  |  |

* Refer to specifications of the individual product for details.

* Select suitable force gauge to correspond with the mounting screws of attachment.

| Related Products | | |
|---|---|---|
| Compression Plates A-40/60 S-40/60 | Conversion Adapter CA series | Chuck for Clamping Cap CCJ-100N/CCJ-100N-01 |
| Ideal for crashing tests. Type A is made of aluminum and Type S is made of steel. | For mounting a M10 screw attachment to a M6 screw thread of a force gauge. | Designed for gripping round-shaped samples tightly by the 4 pins. |
|  |  |  |

* Refer to specifications of the individual product for details.

[Dimension]

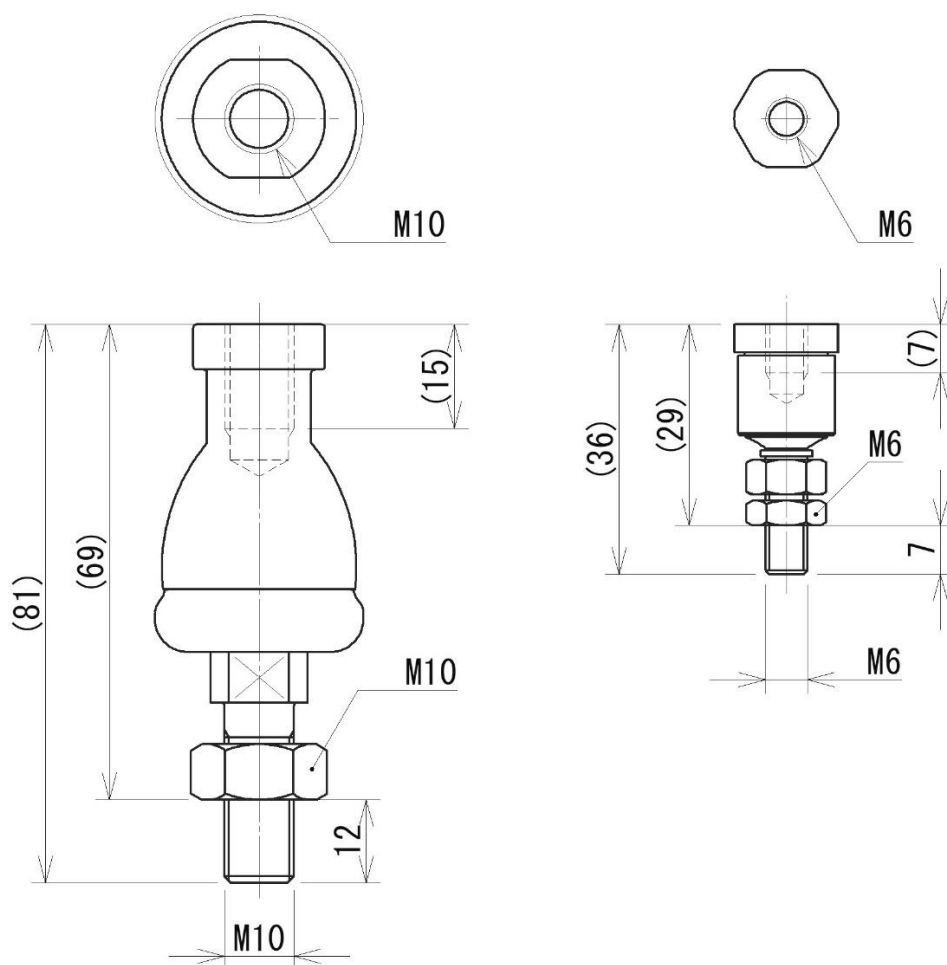

Unit: mm

[Cautions]

- Information in this document is subject to change without prior notice.
- This document is product descriptions and handling precautions, and do not guarantee various characteristics or safety.
- This product is designed for force measurement purpose only.
- Do not copy and use this content without authorization.

IMADA CO., LTD.

99, Jinnoshinden-Cho, Aza, Kanowari, Toyohashi,
Aichi 441-8077, JAPAN
Tel: +81-(0)532-33-3288
Fax: +81-(0)532-33-3866
E-mail: info@forcegauge.net
Website: <http://www.forcegauge.net/en/>



Visit our website for more information on a wide range of product specifications, measurement applications and videos.