

Wire Winding Grip

WG-250N/WG-1000N/WG-5000N

Ideal for tensile test of wire-type material

Winding clamp reduces crimping of sample

The center groove ensures the sample position to pull straight



WG-250N: for tensile test of fiber and thin wire up to 250N



Test Image
(Tensile test of fiber)



WG-1000N: for tensile test of various fiber and wires up to 1000N



Test Image
(Tensile test of copper wire)

Related Standard

- JIS L 1013:2010 [Testing methods for man-made filament yarns] (Partly)
- JIS L 1095:2010 [Testing methods for spun yarn] (Partly)
- JIS L 2511:2000 [Polyester sewing thread] (Partly)

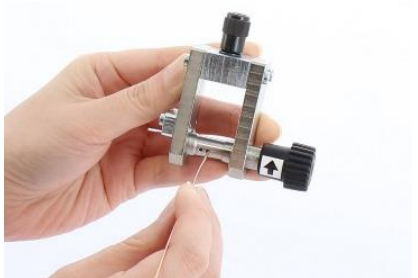
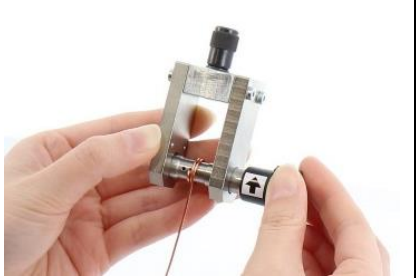
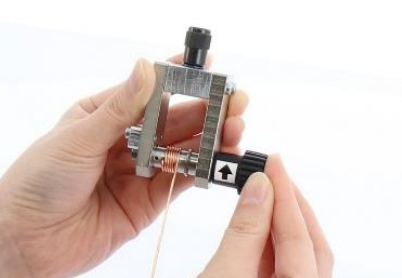
How to install test sample for WG-1000N		
Insert the sample to the hole.	Rotate the knob to wind the sample.	Press the knob to fix the bolt.
		

*The installation of sample is different for WG-250N.

Specifications			
Model	WG-250N	WG-1000N	WG-5000N
Features	Prevents the sample from breaking due to the large bolt diameter.	Designed for tensile test up to 1000N by winding sample with the knob.	Designed for tensile test up to 5000N by winding sample with the knob.
Sample *1	Fiber, Synthetic fiber, Conductive wire, hair	Fiber, Synthetic fiber, Metal single wire, Metal stranded wire	Fiber, Synthetic fiber, Metal single wire, Metal stranded wire
Capacity	250N	1000N	5000N
Method of winding *2	Winding sample by hand	Winding sample by rotating the knob	
Diameter of bolt	Diameter: 17mm	Diameter: 9mm	Diameter: 12mm
Sample diameter	Diameter: 1mm	Diameter: 1.2mm	Diameter: 3mm
Necessary sample length *3	310mm or longer	260mm or longer	320mm or longer
Dimensions	See [Dimensions]		
Weight *4	Approx. 60g	Approx. 180g	Approx. 610g
Mounting Screws	M6		M10



*1 Some samples may not be suitable to grip or test with this product.

Ensure to prepare necessary protection to avoid accidents when testing deformable sample such as spring steel.

*2 Samples which are hard or difficult to wind are not suitable.





*3 This is the length required for having distance of 50mm between the upper and lower parts and 2 rounds winding of the sample (1 round for WG-250N).

*4 Weight of the attachment is also applied as a load on the force gauge. Consider it when selecting the capacity of a force gauge.



Examples of Product Configuration WG-250N		
Example1 Code: 1W2001A		
Simple tensile test up to 50N.		
Digital Force Gauge: DST-50N Motorized Test Stand: MX-500N Optional Attachment: WG-250N (2pcs)		
Example2 Code: 1W2001B		
Complies with the corresponding part of JIS L 1013:2010 and JIS L 1095:2010.		
Force-Displacement Measurement Unit: FSA-0.5K2-500N-L Optional Attachment: WG-250N (2pcs)		
Examples of Product Configuration WG-1000N		
Example1 Code: 1W2002A		
Tensile test up to 1000N with high functionality and versatility.		
Digital Force Gauge: ZTS-1000N Motorized Test Stand: MX2-1000N Optional Attachment: WG-1000N (2pcs) Optional Cable: CB-518 Optional Software: Force Recorder Standard		
Examples of Product Configuration WG-5000N		
Example1 Code: 1W2003A		
Tensile test up to 5000N with high functionality and versatility.		
Digital Force Gauge: ZTS-5000N Motorized Test Stand: MX2-5000N Optional Attachment: WG-5000N (2pcs) Optional Cable: CB-518 Optional Software: Force Recorder Standard		

WG-250N Example2 Image

- * Refer to the specification of each product for details.
- * Product configuration varies depending on the shape and characteristic of the sample, and measurement conditions.
- * The recommended capacity of force gauge varies depending on the expected force to be loaded.
- *1 Analysis of breaking trend by graphing is needed to comply with a part of the standard.

Mountable Force Gauge for WG-500N and WG-1000N		
DST/DSV series	ZTS/ZTA series	FB/PS/PSM series
Digital force gauge with excellent cost-performance capable to manage data with PC.	Digital force gauge with high precision, featuring high sampling rate and a variety of useful functions.	Mechanical force gauge for easy handling.
		
Mountable Force Gauge for WG-5000N		
High capacity ZTS/ZTA series	PSH series	
Digital force gauge with high precision, featuring high sampling rate and a variety of useful functions.	Mechanical force gauge for easy handling.	
		

* Select suitable force gauge to correspond with the mounting screws of attachment.

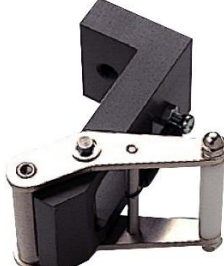
Related Products		
Pin Grip CP-150N	Jacob's Chuck GC-5/GC-15	Roller Grip GC-60/GC-100
Designed for gripping thin wire-type materials.	Ideal for gripping round cylindrical shaped samples.	Attachment designed to hold extensible samples such as rubber, film etc. without slipping.
		

[Dimensions]

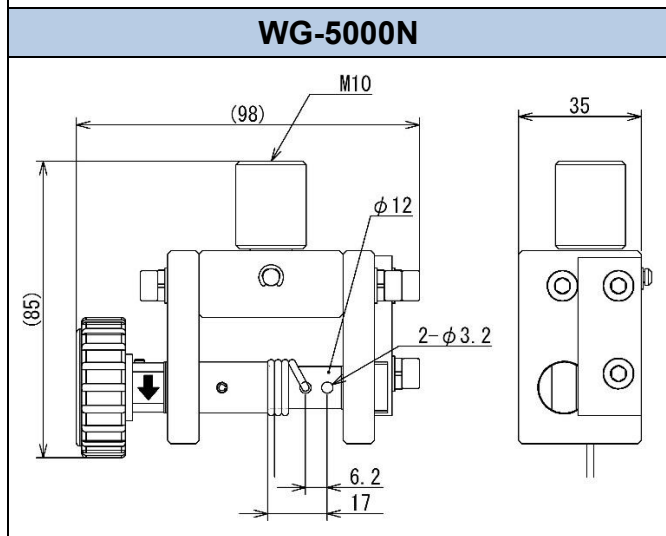
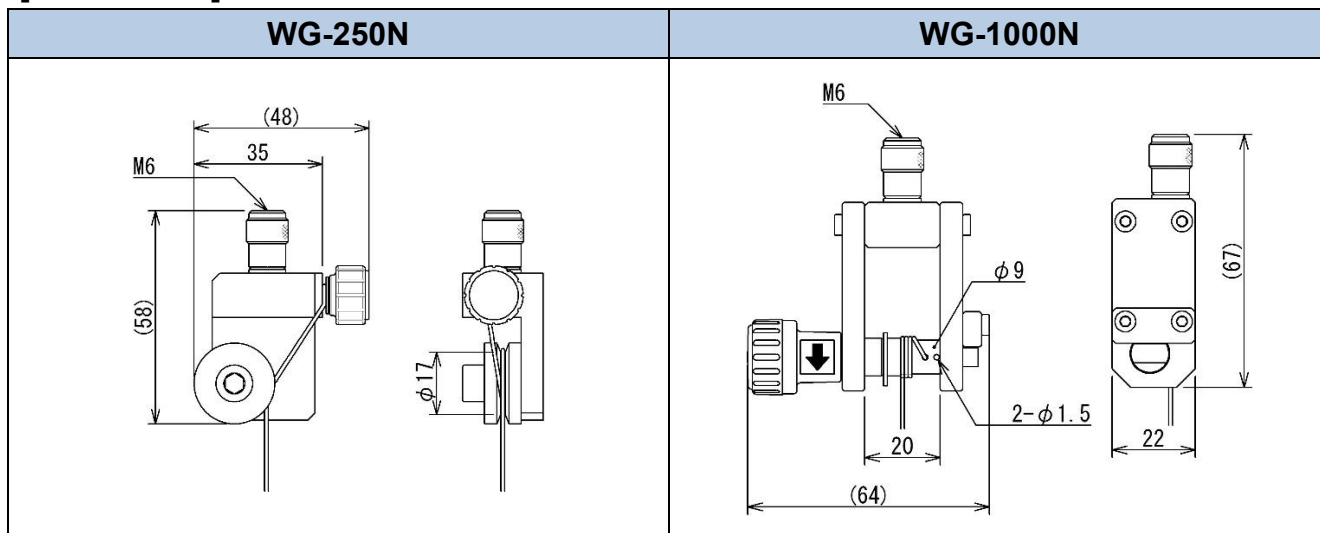

Unit: mm

[Cautions]

- Information in this document is subject to change without prior notice.
- This document is product descriptions and handling precautions, and do not guarantee various characteristics or safety.
- This product is designed for force measurement purpose only.
- Do not copy and use this content without authorization.
- A force gauge (sold separately) is required to use this product.
- Some samples may not be suitable to measure with this product.

<p>IMADA CO., LTD 99 Jinnoshinden-cho aza Kanowari Toyohashi Aichi Japan 441-8077 Tel: +81-(0)532-33-3288 Fax: +81-(0)532-33-3866 E-mail: info@forcegauge.net Website: http://www.forcegauge.net/en/</p>		<p>Visit our website for more information on a wide range of product specifications, measurement applications and videos.</p>
--	--	---